

STRAINERT WIRELESS LOAD CELL  
RECEIVER / TRANSMITTER  
MODEL J-Unit1  
USER MANUAL





Strainsert Company  
12 Union Hill Road  
West Conshohocken, PA 18914  
United States of America

Phone: 610-825-3310

Fax: 610-825-1734

<http://www.strainsert.com>

2015 Strainsert Company

Document J-Unit1

May 6, 2015

## Table of Contents

Introduction.....	4
Strainsert Wireless Load Monitoring System Capabilities.....	4
Safety Information.....	5
Warranty Information.....	6
Radio Requirements.....	7
System Overview.....	8
Equipment.....	9
J-Unit1 Mounting Requirements.....	10
J-Unit1 Interface Connections.....	11
Mini Gateway Mounting Requirements.....	12
Mini Gateway Front Port Identification.....	12
Minimum System Requirements.....	13
Software Installation.....	14
Hardware Installation.....	16
Application Quick Start-up.....	16
Load Monitor Tab Field Descriptions.....	23
Configuration Tab Field Description.....	25
Field Calibration Tab Field Description.....	29
Field Calibration Procedure.....	31
Data Logging.....	34
Battery Installation / Replacement.....	35
Troubleshooting.....	36
Customer Support.....	38

## Introduction:

The STRAINsert Model J-Unit1 Wireless Load Cell Receiver / Transmitter Load Monitoring Software provides a convenient method of displaying force readings on a computer through a wireless interface. The program provides monitoring capability for up to 5 Model J-Unit1 devices. These can be configured as single axis, bi-axial, or dual bridge. Each Model J-Unit1 includes a durable battery capable of over 5000 hrs. of operations at line of sight distances up to 3000 feet. Data Logging and Field calibration capabilities are also provided.

## Strainsert Wireless Load Monitoring System Capabilities

### Sensor Type:

Bridge Resistance: 350 Ohms (Min.)

Bridge Type: Full Bridge

Minimum Sensitivity: 1-mV/V

Accepts 1ea. single or dual bridge sensor

Maximum Number of J-Unit1's per System: 5

Unipolar / Bipolar Operation

Units: lbs., KIPS, Tons, Metric Tons, kg, KN

Sensor Excitation: 2.075 VDC

Transmission Distance:

Range	Minimum (ft)	Line of Sight (ft)
Standard	30	>3000
Short	1	>500

Carrier Frequency : 916 Mhz Spread Spectrum Frequency Hopping

Data Update Rate: Readings are averaged over 250ms cycle and transmitted once per second.

A/D Resolution: 0.04% Unipolar Mode / 0.08% Bipolar Mode

Estimated Battery Life: 5,000 hours

Calibration: Field adjustable

Operating Temperature: -10 to +65 °C (+14 to +149 °F)

Enclosure Dimensions: 4.80"[121.9](W) x 4.74"[120.4](L) x 3.27"[83.1](H)

Enclosure Rating : IP66 / NEMA 4X

## Safety Information

### General Safety

Do not install or work on this equipment unless you have read and understand the instructions and warnings in this Manual. Proper care is your responsibility

Failure to heed any warnings may result in serious injury or death.



#### WARNING!

Use caution and follow applicable safety procedures when using wireless sensors. This program DOES NOT provide safety or emergency stop devices.



#### CAUTION!

Improper scaling of the Load Sensor may result in readings that do not represent actual applied loads and may cause damage to sensor and/or the surrounding structure, in addition to potential personal injury. The Customer must verify that all data entry values are correct and are entered in the proper fields.

## Warranty Information

### The Two Year Guarantee

Strainsert wireless force sensor products are guaranteed for a period of two years, after shipment to original purchaser, against any malfunction due to defects in materials or workmanship

Strainsert Company is not liable for consequential or contingent damages and its liability is strictly limited to the original purchase price of the product or its repair or replacement at Strainsert's option.

Strainsert Company will repair or replace under warranty, and return transportation prepaid, provided that:

- Full explanation of malfunction or defect is transmitted in writing to Strainsert Company; together with, if possible, application or short history of product use.
- Authorization to return product is obtained from Strainsert Company.
- Product is sent to Strainsert Company, 12 Union Hill Road, West Conshohocken, PA 19428, prepaid, properly packaged and insured at full value.
- Factory inspection and investigation discloses that malfunction or defect developed or appeared during normal and proper usage of product.
- This warranty is null and void in the event repairs or modifications are made by persons unauthorized by Strainsert Company.

### **Notes:**

1. To initiate warranty repair work, ALL above conditions must be complied with fully.
2. For beyond warranty repair work, the same conditions apply.
3. Calibration and/or investigation charges may apply when Strainsert products returned for warranty repair prove to be free of defect, and the problem lies in systems, components, circuits, test set-ups, etc., for which Strainsert has no responsibility.
4. For some special systems, Strainsert may utilize other manufacturers products. In these cases, the original equipment manufacturers warranty will apply.

## Radio Requirements

This device complies with Part 15 of the FCC Rules. Operation is subject to the following two conditions:

1. This device may not cause harmful interference, and
2. This device must accept any interference received, including interference that may cause undesired operation.

To comply with FCC and Industry Canada RF radiation exposure limits for general population, the antenna(s) used for this transmitter must be installed such that a minimum separation distance of 20cm is maintained between the radiator (antenna) and all persons at all times and must not be co-located or operating in conjunction with any other antenna or transmitter.

## System Overview

Up to 5 J-Unit1's with dual bridge configuration can communicate to a single mini gateway





## Equipment

1. Model J-Unit1 Transmitter / Receivers – includes battery, transmitter / receiver circuit board (1ea.)
2. Model Nearson S161AH-915R, Fixed right-angle (1ea.)
3. ModFLEX Mini Gateway – includes articulating antenna, USB cable (1ea.)
4. Installation CD (1ea.)

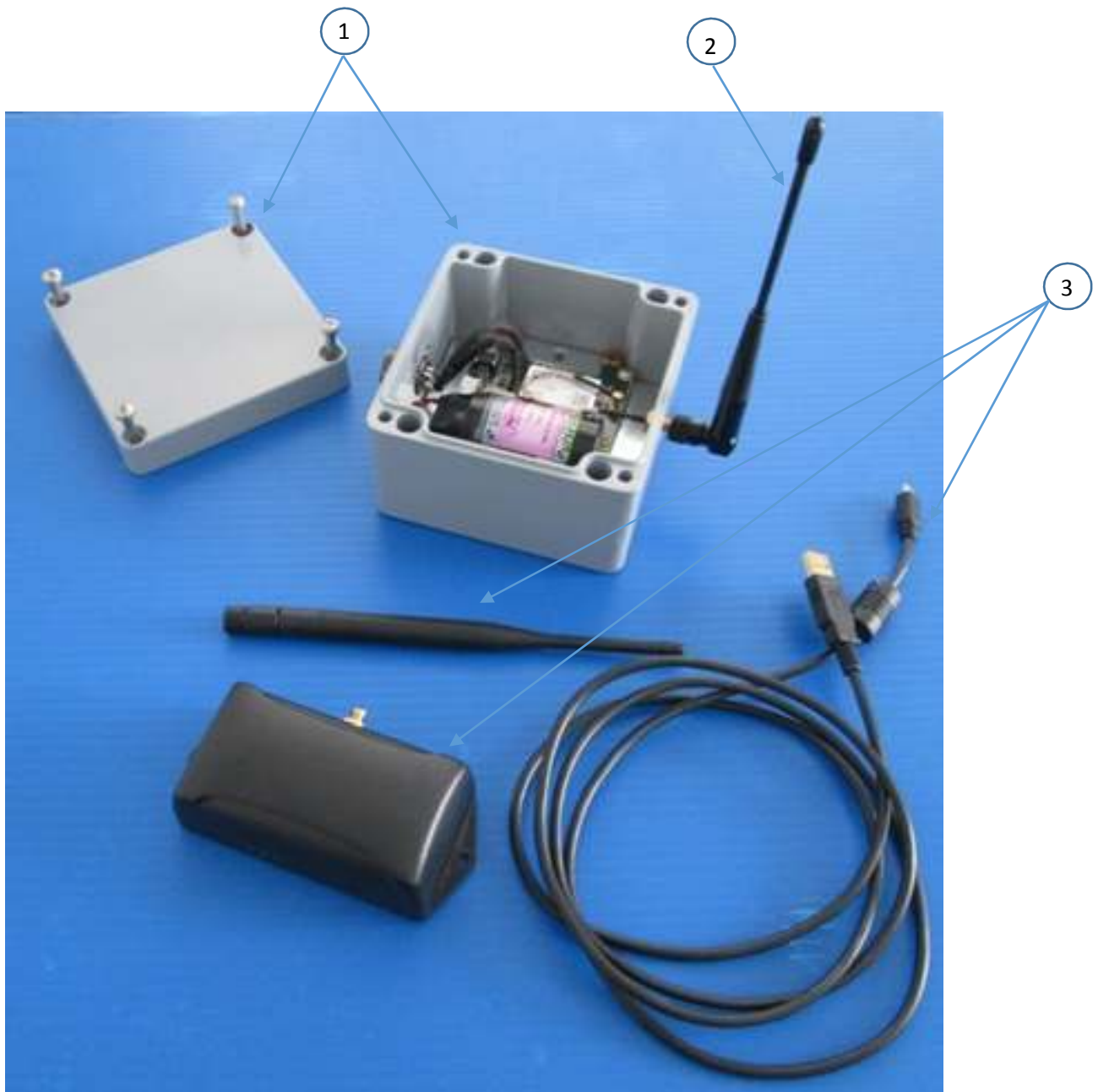

### J-UNIT1 Mounting Requirements

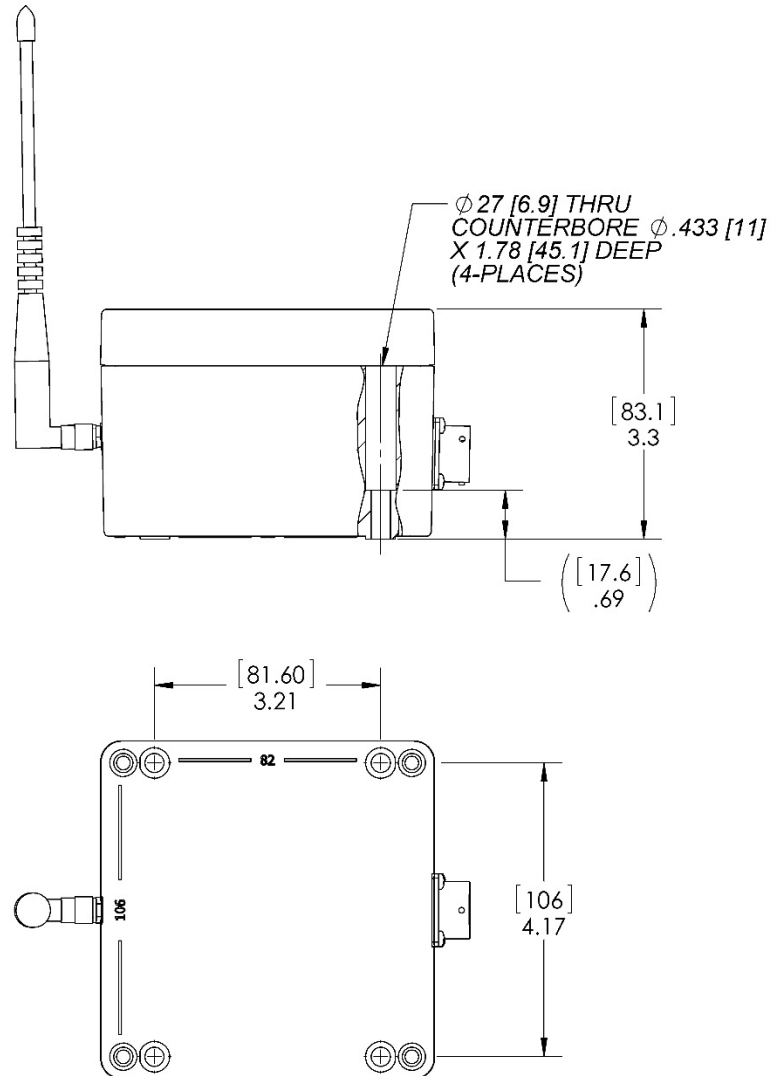

J-UNIT1 Interface Connections

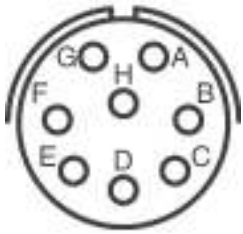

<u>J-Unit1</u> <u>Receptacle</u>		<u>Description</u>
Pin A	-----	Excitation (+); Bridge #1
Pin B	-----	Signal (+); Bridge #1
Pin C	-----	Signal (-); Bridge #1
Pin D	-----	Excitation (-); Bridge #1
Pin E	-----	Excitation (+); Bridge #2 (*)
Pin F	-----	Signal (+); Bridge #2 (*)
Pin G	-----	Signal (-); Bridge #2 (*)
Pin H	-----	Excitation (-); Bridge #2 (*)
Shield	-----	Attach to mating connector shell

(\*) Only if available as an option.

### Mini Gateway Mounting Requirements

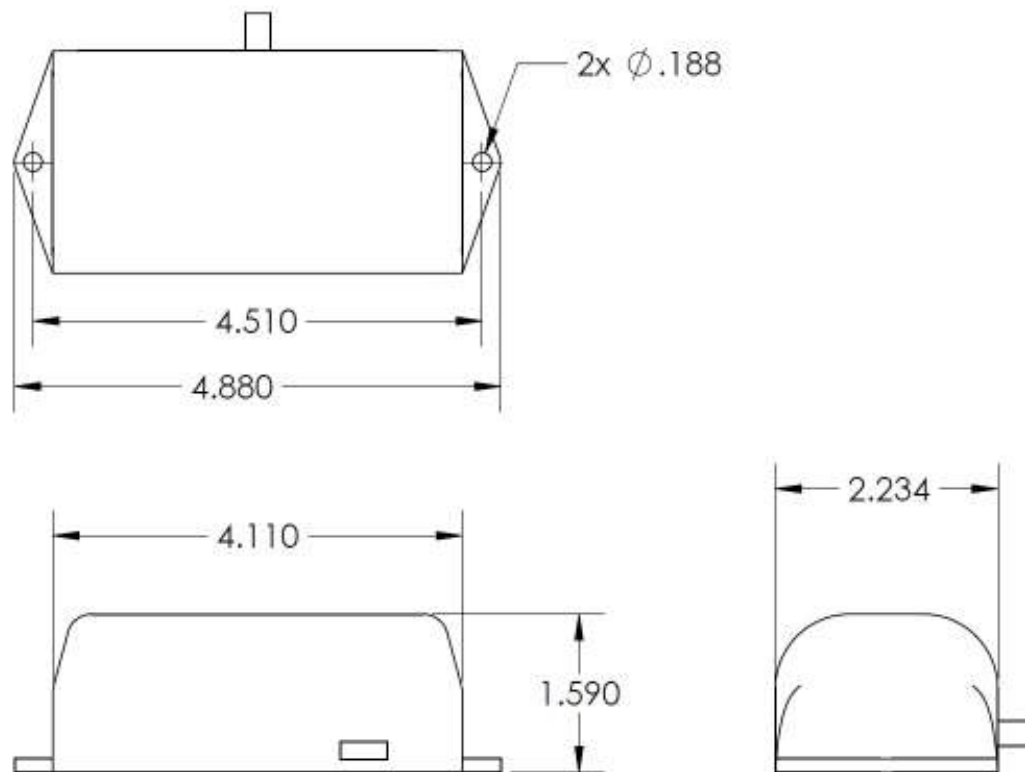

### Mini Gateway Front Port Identification

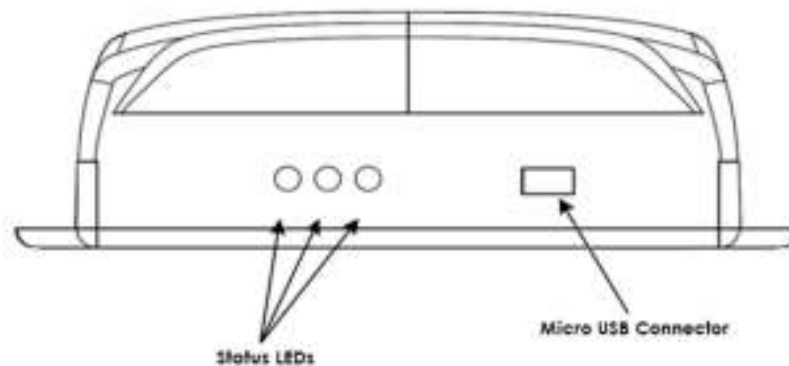

Green – Indicates that the Gateway module is operational (heartbeat)

Yellow – Indicates that there is activity on the host interface

Red – Indicates RF activity

Minimum System Requirements for Software

Operating System: Windows XP Professional Version 202 Service Pack 3

Processor: 2GHz

RAM: 2GB

Hard Drive: 50MB of free space

## Software Installation

1. Run Strainsert Installer program from CD provided. Minimum system requirements: Windows XP.
2. The installer will guide the user through the installation with prompts as follows:

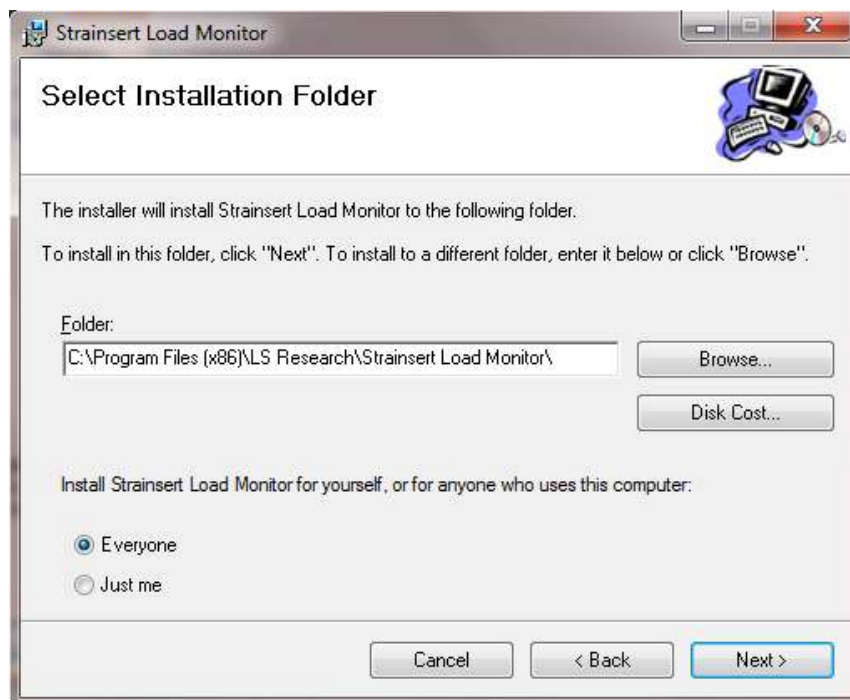

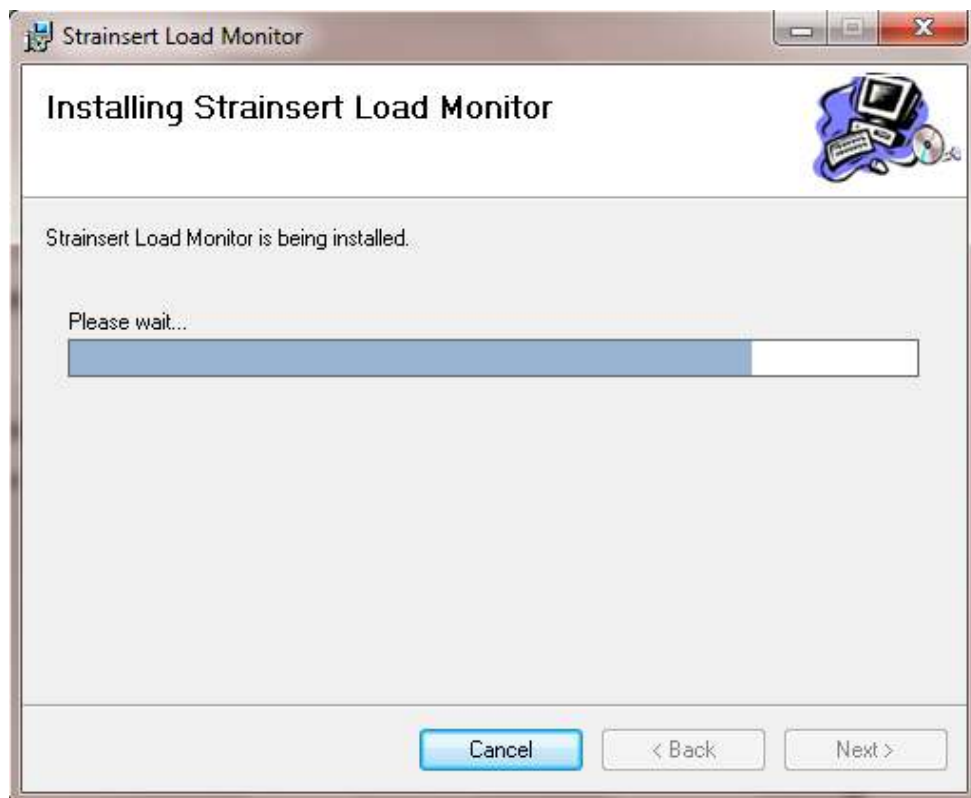
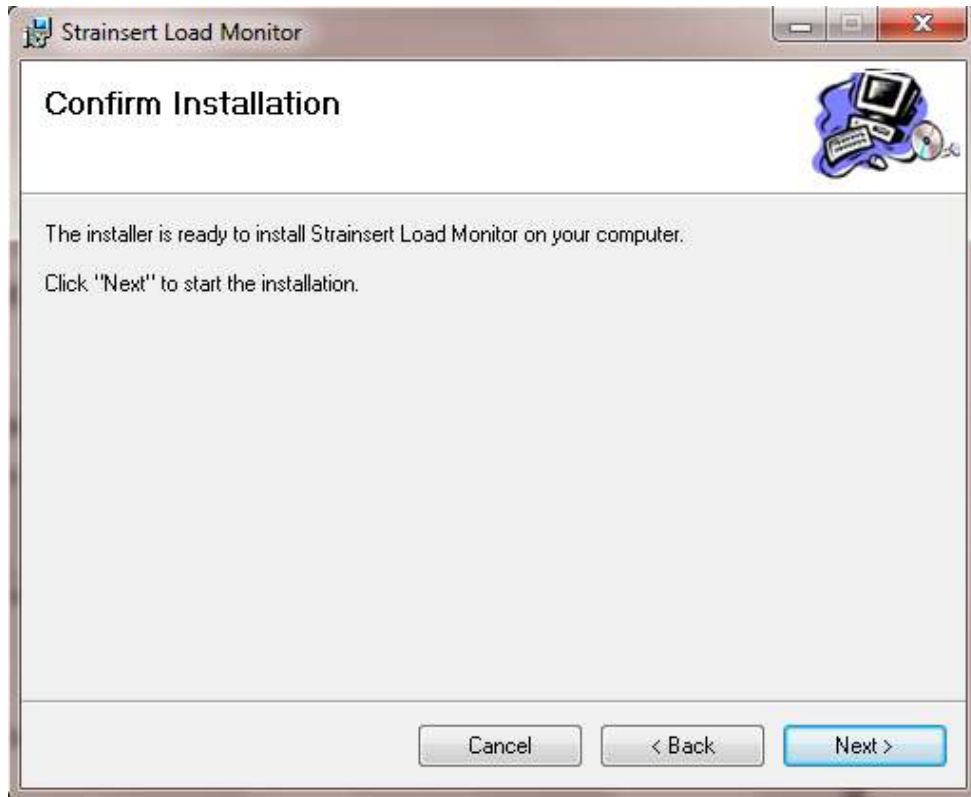

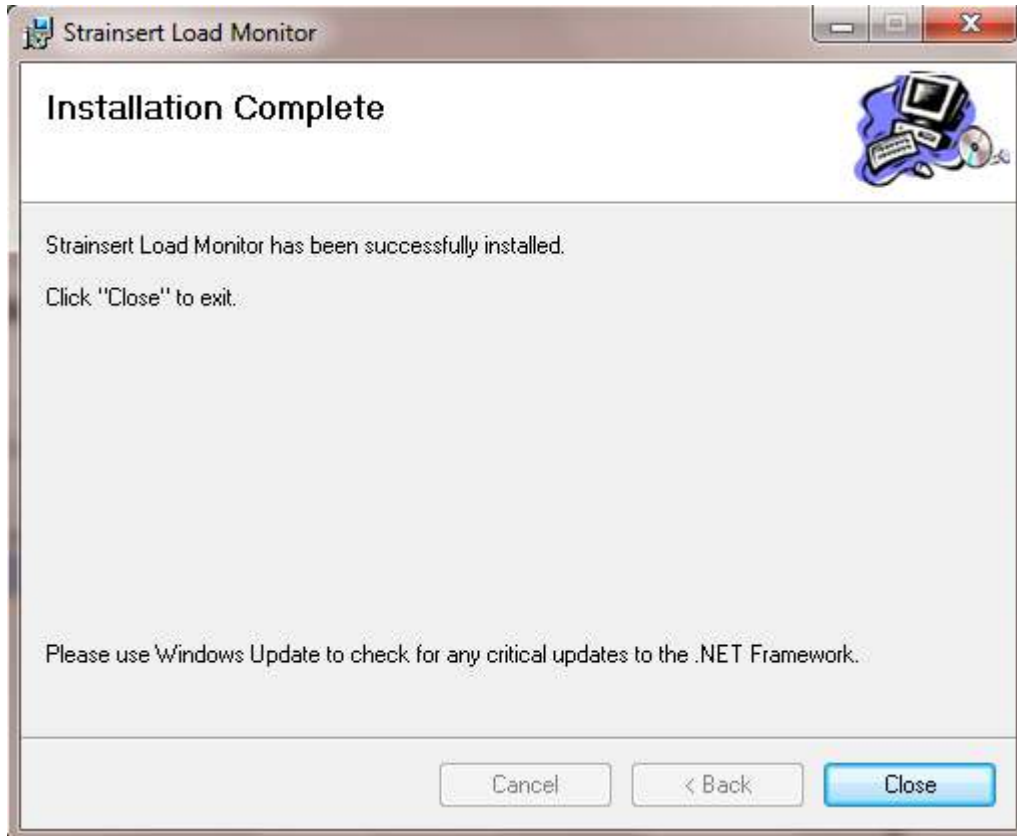

### Hardware Installation

1. Connect ModFLEX Mini Gateway USB cable to computer USB port.
2. Connect the articulating antenna to Mini Gateway
3. Connect sensor cable (not included) to the Transmitter / Receiver enclosure and the other end to the Strainsert sensor.
4. Connect the right angle antenna to the Transmitter / Receiver enclosure.

### Application Quick Start-up

1. After connecting the ModFLEX Mini Gateway, pc or lap top will install device drivers.

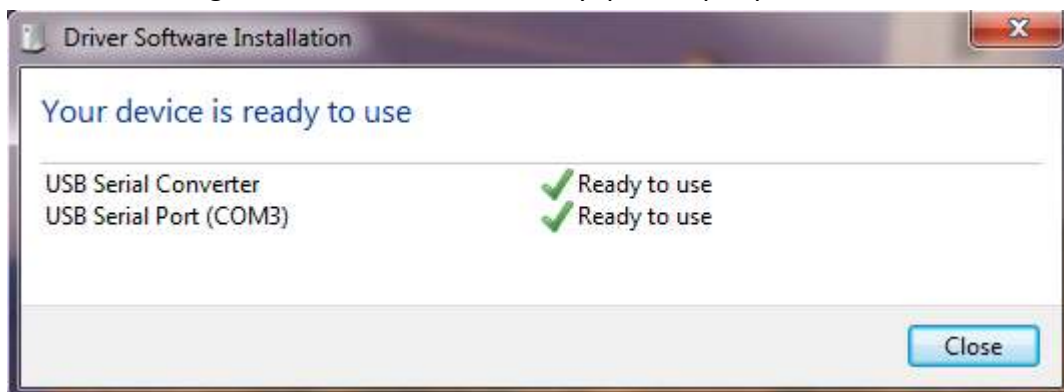



2. Re-boot your computer.
3. After re-boot, open Strainert Load monitor application.



4. The application will open to the **Load Monitor** tab which will be blank.

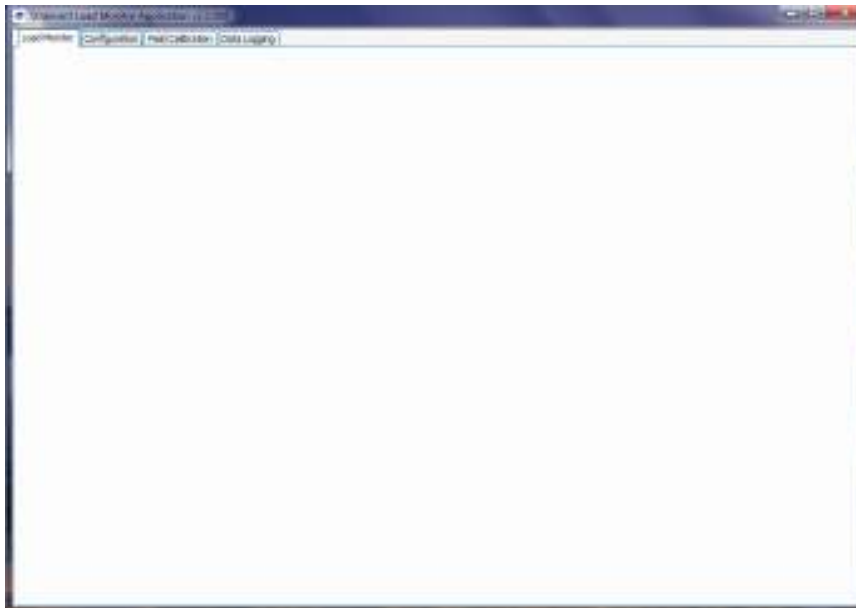

5. Select the **Configuration** tab.

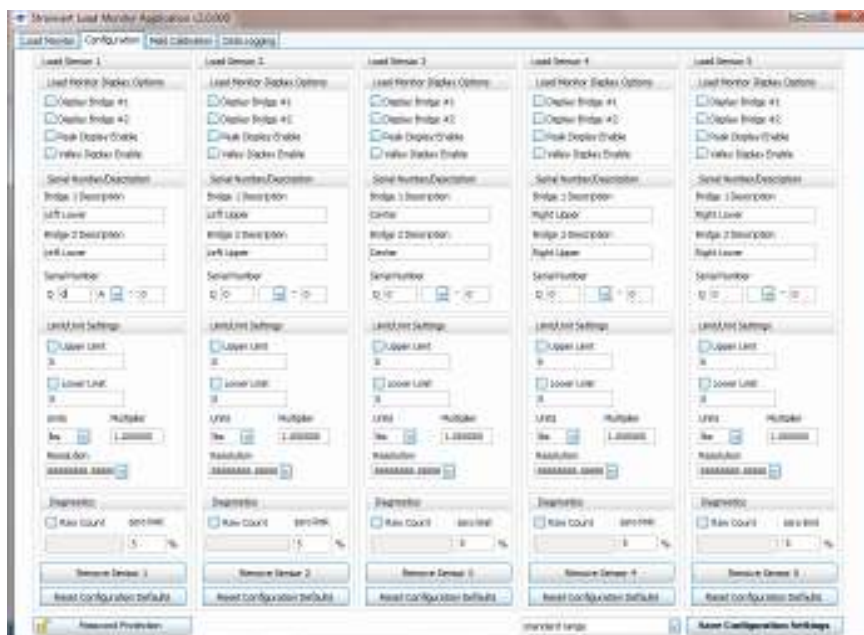

- On the **Configuration** tab enter the sensor **Serial Number(s)** and select the **Display Bridge #1** check box for single axis load cell and **Display Bridge #2** check box for dual bridge or bi-axial load cells under the **Load Monitor Display Options**.

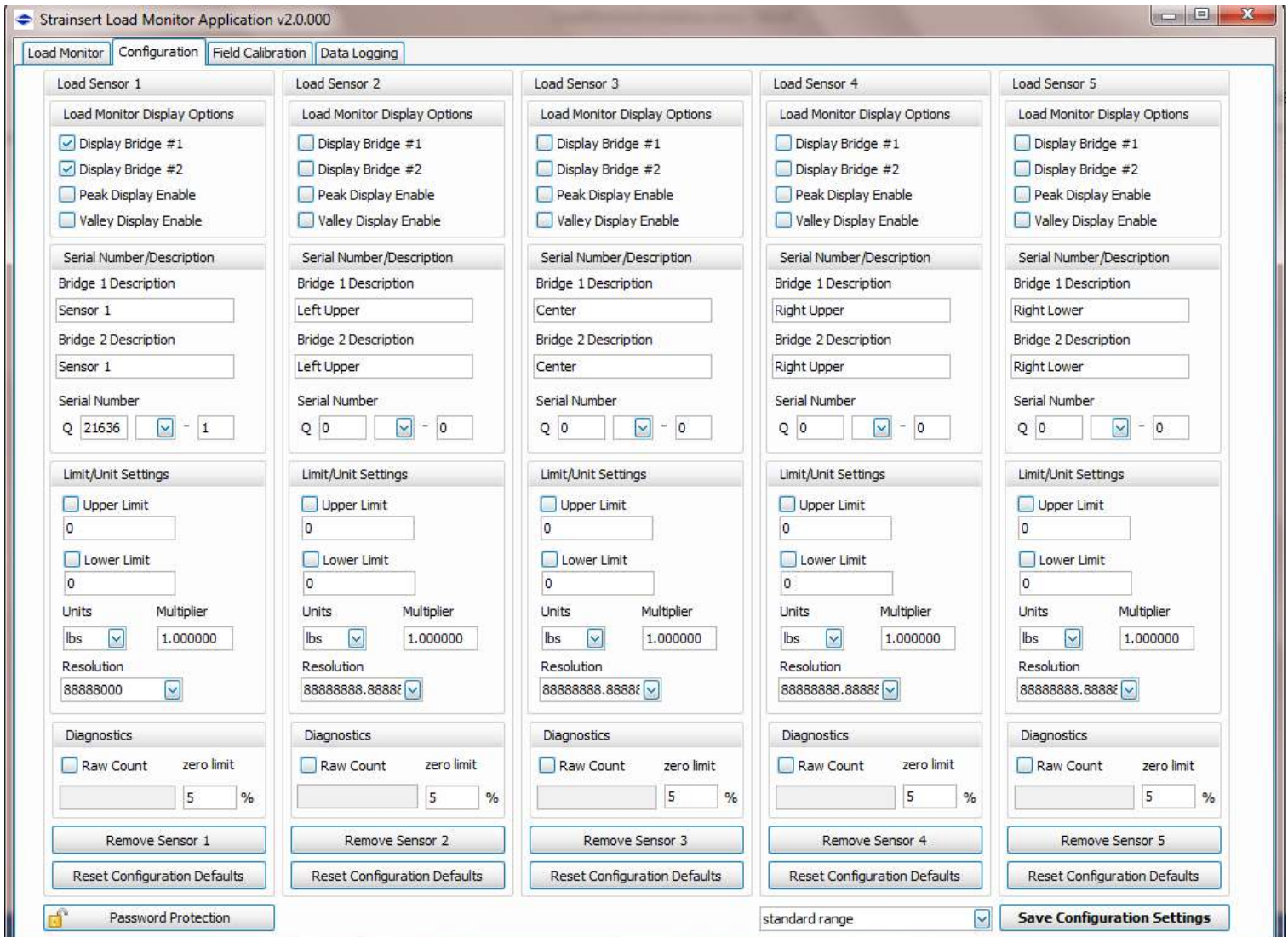

- After selections, **Save Configuration and Settings**.
- To establish communication between the gateway and the **Transmitter / Receiver** unit, return to the **Load Monitor** tab.
- The Load Monitor tab will display each selected sensor and bridge. The initial communication link can take up to 3 minutes to connect.
- Each bridge will indicate the attempt to connect by displaying **Searching** in a message for each sensor / bridge. NOTE: In the upper right corner of each sensor / bridge a red circle with a slash indicates no communication

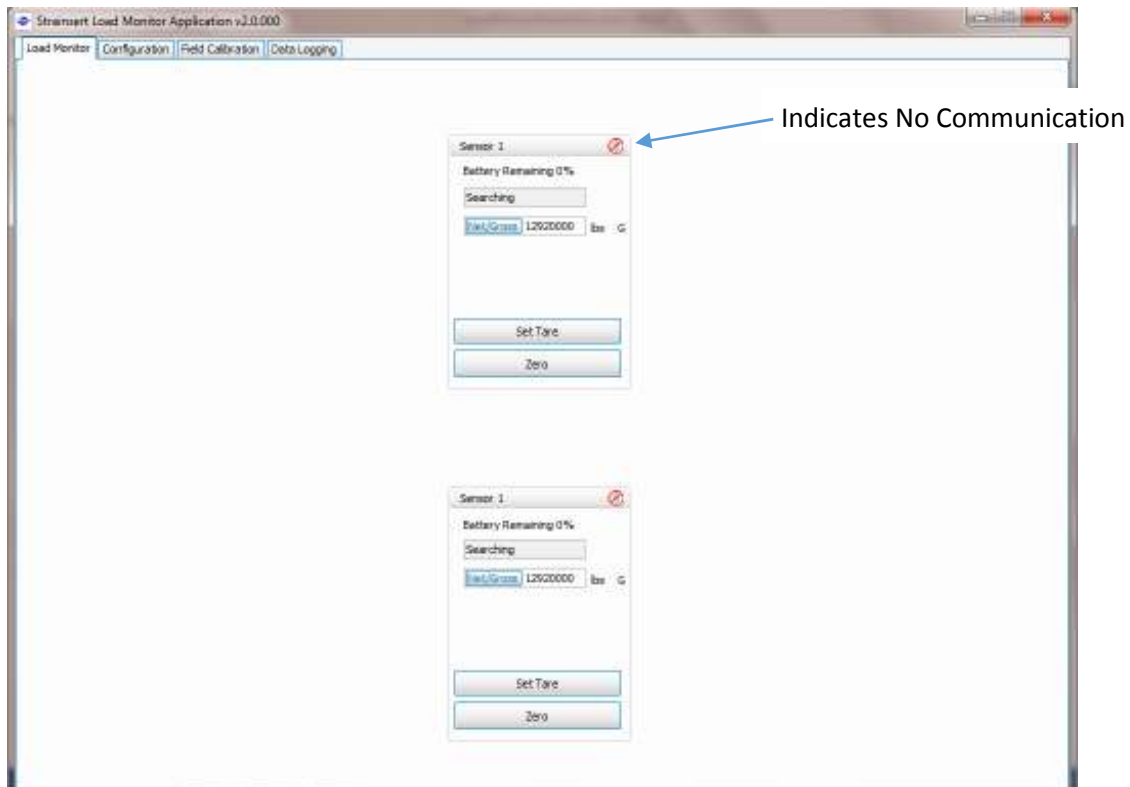

11. After communication is established, bars in the upper right corner will indicate signal strength and the sensor / bridge load readings should be displayed in lbs.



12. With no-load on the sensor, use **Zero** icon to null the sensor / bridge

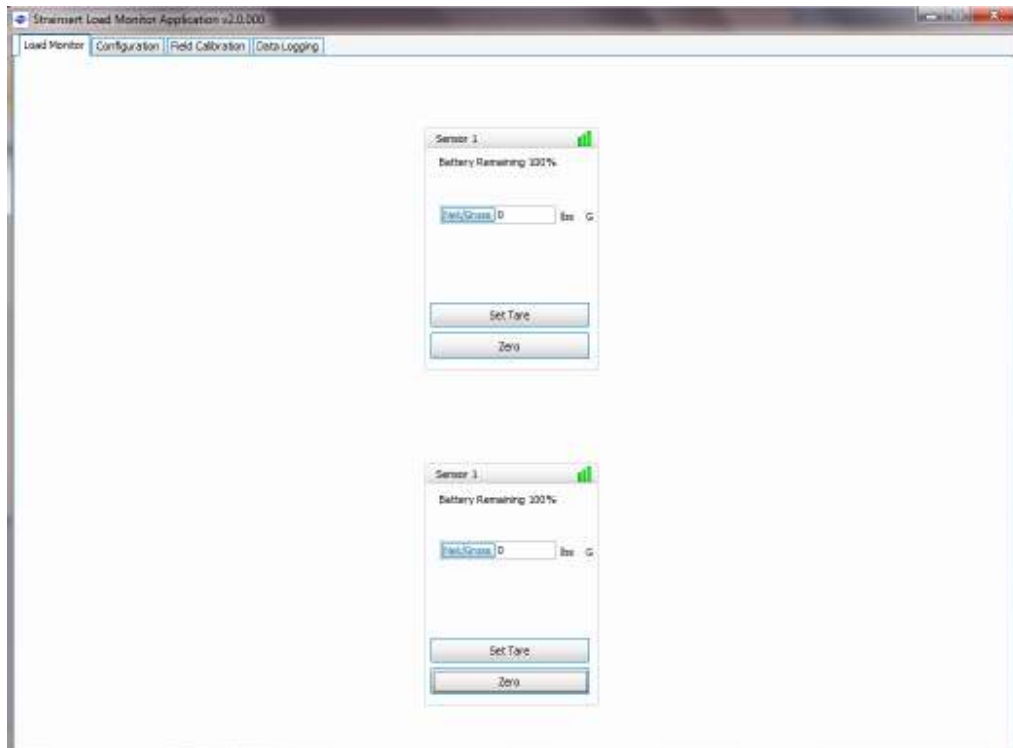

13. After zeroing the display, all readings are **Gross** measurements which is indicated on the display with a “G” to the right of the engineering units.

14. The user may add any required Tare to the system at this point. Tare loads are stored when the user presses the **Set Tare** icon under each sensor / bridge display.

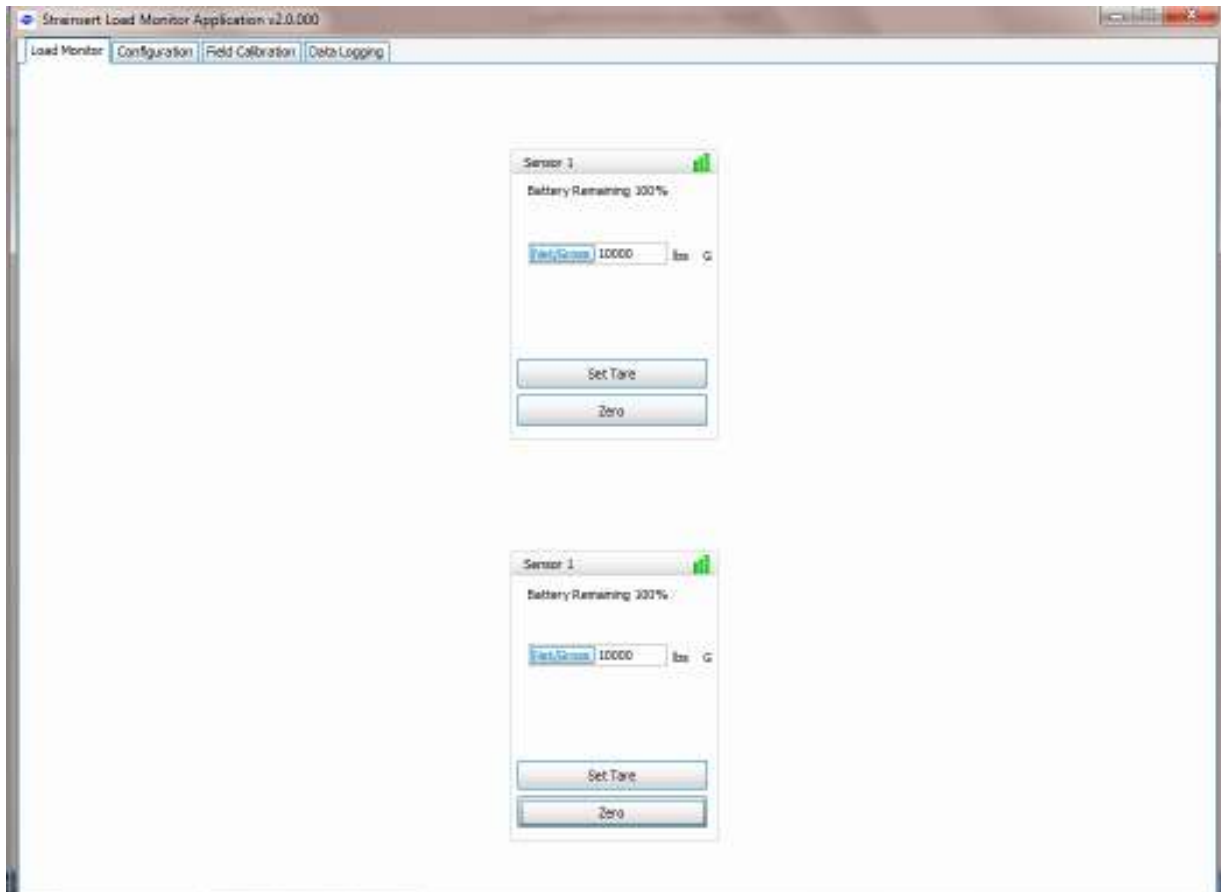

15. Presses the **Net/Gross** button the left of the load display to toggle between the tared and untared condition. The **Net** mode is indicated with a “**N**” to the right of the engineering units.

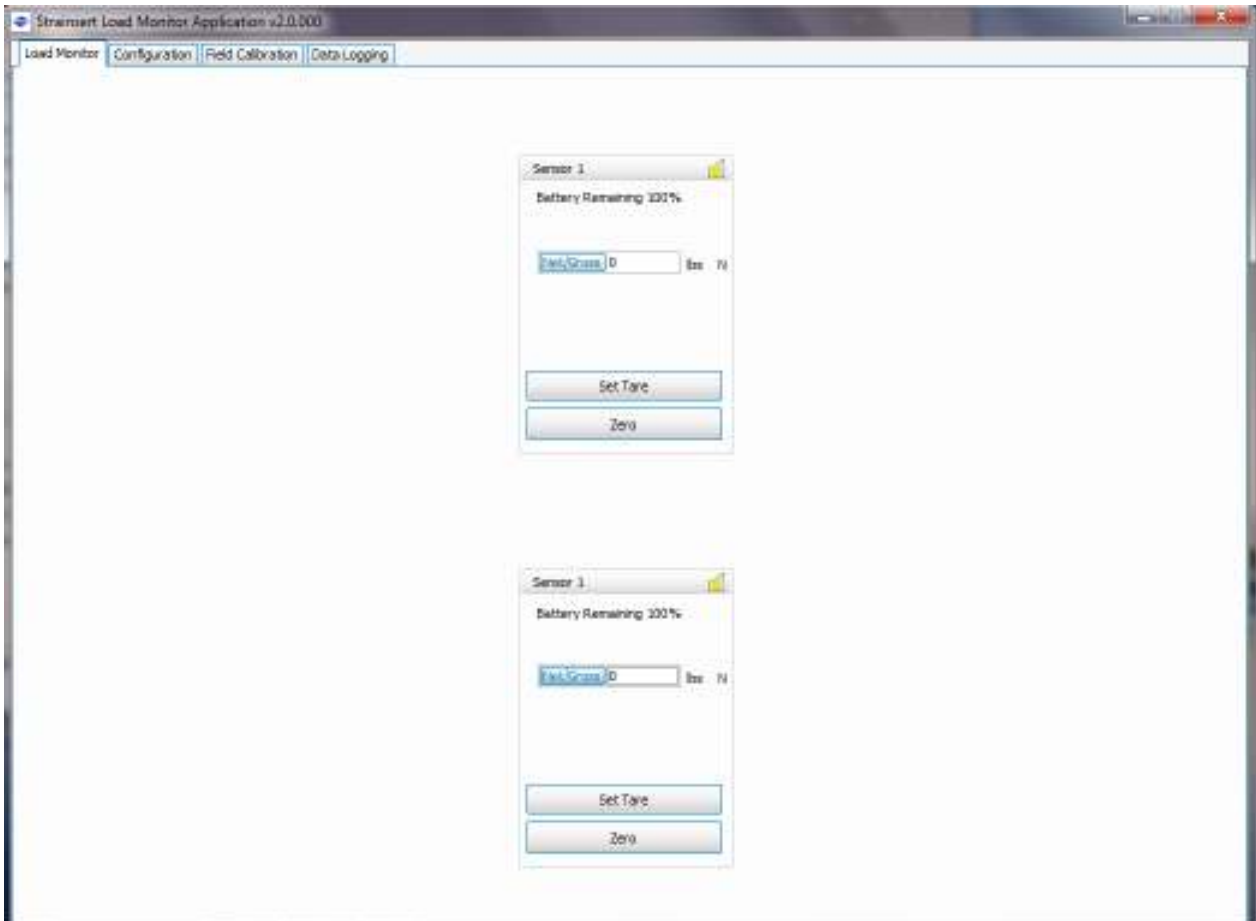

16. The user closes out communication between the sensor and the gateway by pressing the “X” in the upper right hand corner of the application window.
17. With all configuration settings saved, the user can re-open the application at a later time and re-establish communication with the saved sensors.

## Load Monitor Tab Field Descriptions

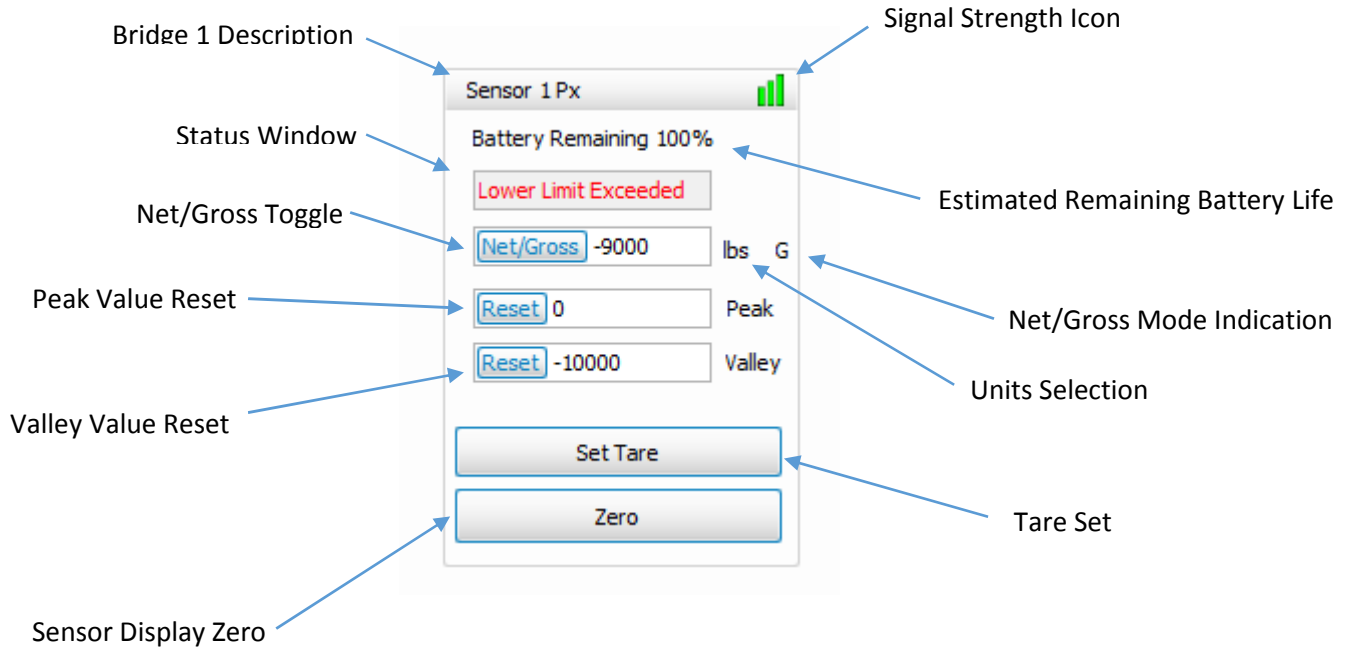

Bridge 1/2 Description: Configuration tab text field as assigned for user.

Status Window: Indicates communication status, Upper / Lower Limit condition, Over and Under Range conditions. During normal operating conditions, the Status window is hidden.

Searching – Wait period message during sensor / gateway communication synchronization (may take up to 3 minutes)  
 No Comms – Indicates no communication between gateway and sensor  
 OVER-RANGE – Sensor A/D maximum exceeded  
 UNDER RANGE – Sensor A/D minimum exceeded  
 Upper Limit Exceeded – Set on Configuration tab  
 Lower Limit Exceeded – Set on Configuration tab

Net/Gross Toggle: Enables user to switch between Gross and Net measurements based on user Set Tare

NOTE: If closed and re-opened at any time, the application will always open in the Gross mode.

Peak Value Reset: Clears the last stored peak reading.

Valley Value Reset: Clears the last stored valley reading.

**Sensor Display Zero:** The Zero icon is used to null the sensor display with no load applied and is stored in non-volatile memory within the Strainsert Load Monitor application. The allowable Zero Limit can be changed on the Configuration tab. The default value is 5%. The maximum allowable Zero Limit is 40% of the full scale range of the sensor A/D.

**Signal Strength Icon:** Color coded indication of relative transmission quality

**Remaining Battery Life:** Percentage display of battery strength (remaining battery life is relative to consumption; displayed percentage of battery output)

**Net/Gross Mode Indication:**

G – Indicates Gross Mode

N – Indicates Net Mode

**Units Selection:** User selected engineering units set on Configuration tab with Units drop down. Default units are “lbs”.

**Tare Set:** Stores the user applied tare weight in non-volatile memory within the Strainsert Load Monitor application.

**NOTE:** The user can Tare up to the full range of the sensor A/D. However, the usable span of the sensor is limited by the amount of Tare.



Configuration Tab Field Description

Enables Bridge #1 /#2 Display on Load Monitor Tab

Enables Peak / Valley Display on Load Monitor Tab

**Load Monitor Display Options**

Display Bridge #1

Display Bridge #2

Peak Display Enable

Valley Display Enable

Bridge #1 /#2 Load Monitor Tab Labels

Sensor Serial Number: User enters exact serial number of sensor.

Note: Serial Number is the ID required for the Load Monitor application to synchronize with the sensor receiver / transmitter.

**Serial Number/Description**

Bridge 1 Description

Sensor 1 Px

Bridge 2 Description

Sensor 1 Py

Serial Number

Q 21636  - 1

Found on sensor nameplate and/or Strainsert Calibration Certificate

Note: "Q" is not required

If no letter suffix is included in the serial number, leave blank.

Enter numeric found after the dash in the serial number

Upper Limit / Lower Limit– When checked, if Load Monitor displayed value exceeds the entered limit, a message box is triggered on Load Monitor Tab.

Defaults to unchecked

Upper Limit defaults to sensor capacity and cannot be edited if check box is left unchecked.

Lower Limit defaults to 0 and can be edited independent of the check box condition.

Units selection drop down – Defaults to “lbs”.

User can choose from different engineering units for display on the Load Monitor tab.

Upper / Lower Limits are recalculated based on the selection of units.

Resolution – The minimum unit of change displayed on the Load Monitor tab (i.e. 100, 1000, etc.).

The choices of Resolution in the drop down are limited by the sensor capacity, sensitivity and the range of the A/D. The application will determine what choices are allowed in the drop down.

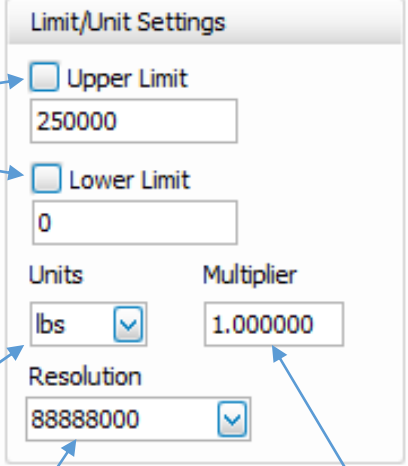

Multiplier defaults to 1.000000. Can be used for custom scaling.

Note: When Multiplier is not equal to the default, an “M” will be displayed to the left of the Net/Gross icon on the Load Monitor tab.

Raw Count – When checked provides the user with the ability to see the A/D counts for both bridge #1 / #2.

Defaults to unchecked

Capacity: 2,457 (Uni-polar Mode) / 1,229 (Bi-polar Mode)

A/D Over Range: 3,768 counts

A/D Under Range: 327 counts

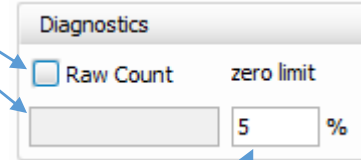

Zero Limit – Allowable percentage that the can be used to null the sensor output. This value is stored within the application and is retained until the user activates a new Zero.

Note 1: Default value is 5%

Note 2: The Zero limit is based on the absolute full scale output of the A/D operating range.

Removes all sensor information including Serial Number entries and any previously saved configuration settings.

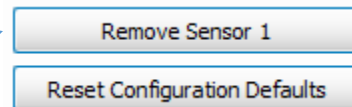

Resets all configuration settings to original defaults but retains serial number information.

Transmission Range – There are two range selections:

1. Standard Range (default)
2. Short Range (sensor to transmitter distances < 30-ft)

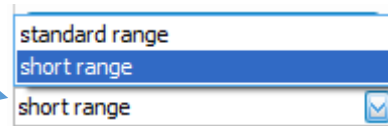

Save Configuration Settings – User must save all configuration changes after edits for changes to take effect.

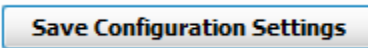

Password Protection – Entry of a password disables changes to the Configuration and Field Calibration tabs.

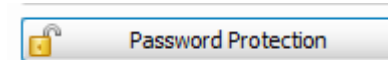

Note: Must Save Configuration Settings prior to attempting to set password.

Field Calibration Tab Field Description

Device List – Select sensor to be field calibrated from the drop down.

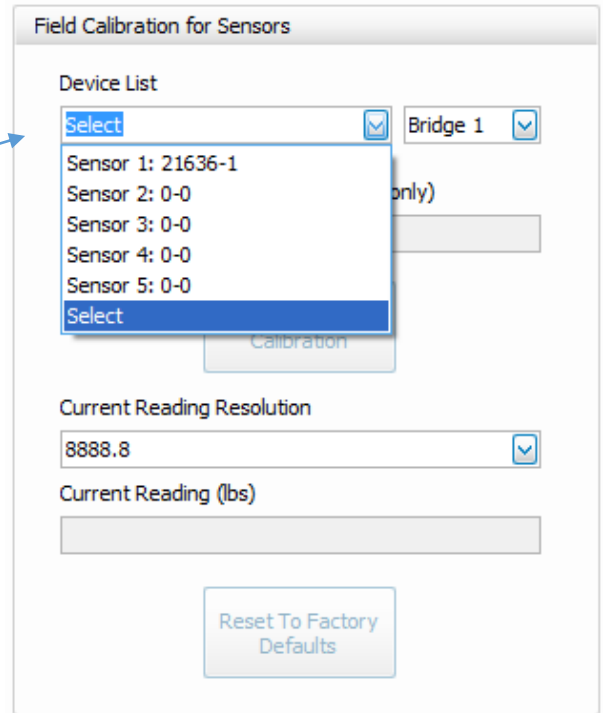

The screenshot shows the 'Field Calibration for Sensors' window. The 'Device List' dropdown menu is open, displaying a list of sensors: 'Sensor 1: 21636-1', 'Sensor 2: 0-0', 'Sensor 3: 0-0', 'Sensor 4: 0-0', and 'Sensor 5: 0-0'. The 'Select' option is highlighted at the bottom of the list. To the right of the dropdown, the 'Bridge 1' dropdown menu is also visible. Below the device list, there is a 'Current Reading Resolution' dropdown set to '8888.8' and a 'Current Reading (lbs)' input field. A 'Reset To Factory Defaults' button is located at the bottom of the window.

Select Bridge (if applicable) to be field calibrated.

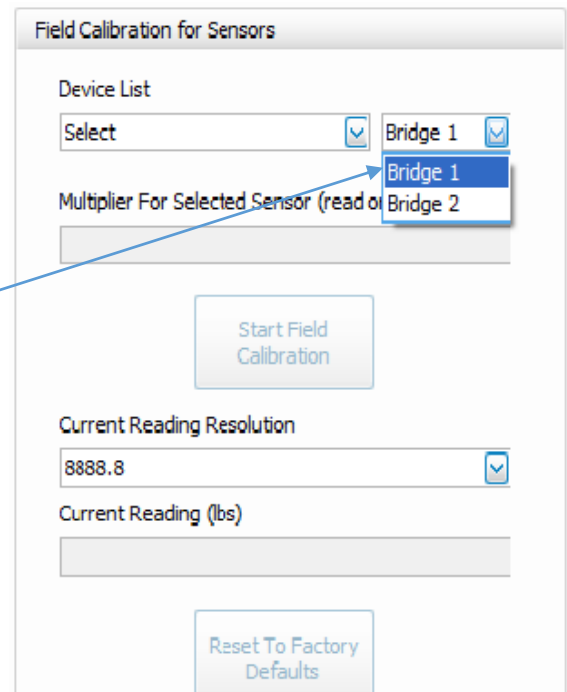

The screenshot shows the 'Field Calibration for Sensors' window. The 'Device List' dropdown menu is closed and shows 'Select'. The 'Bridge 1' dropdown menu is open, displaying a list of bridges: 'Bridge 1' and 'Bridge 2'. The 'Bridge 1' option is highlighted. Below the bridge list, there is a 'Multiplier For Selected Sensor (read of)' input field. A 'Start Field Calibration' button is located below the multiplier field. Below that, there is a 'Current Reading Resolution' dropdown set to '8888.8' and a 'Current Reading (lbs)' input field. A 'Reset To Factory Defaults' button is located at the bottom of the window.

Multiplier For Selected Sensor – Displays the Multiplier entered on the Configuration Tab.

Start Field Calibration – Icon initiates the field calibration sequence.

Current Reading Resolution – Gives the user the capability to adjust precision during field calibration to increase accuracy.

Current Reading (lbs) – Displays the current live weight reading.

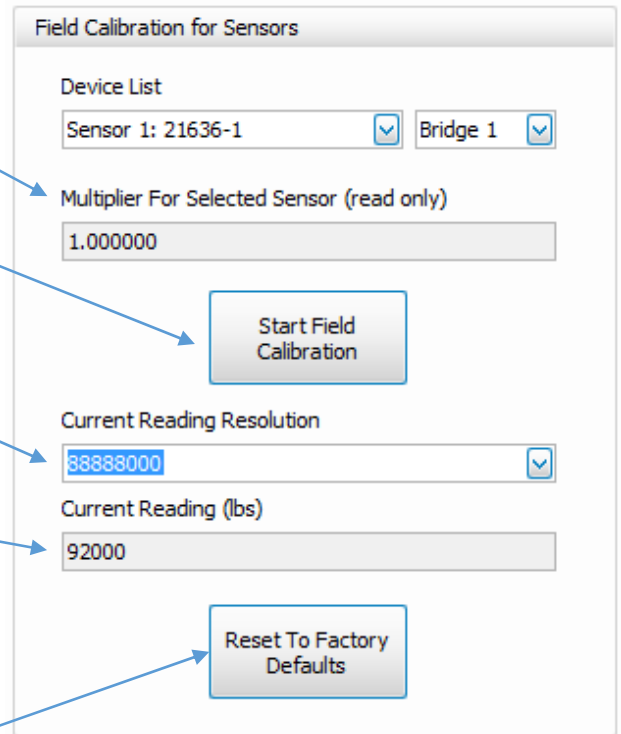

The screenshot shows a software window titled "Field Calibration for Sensors". It contains the following elements:

- Device List:** Two dropdown menus, "Sensor 1: 21636-1" and "Bridge 1".
- Multiplier For Selected Sensor (read only):** A text field containing "1.000000".
- Start Field Calibration:** A button.
- Current Reading Resolution:** A dropdown menu showing "88888000".
- Current Reading (lbs):** A text field containing "92000".
- Reset To Factory Defaults:** A button.

Blue arrows from the text on the left point to the "Multiplier For Selected Sensor" field, the "Start Field Calibration" button, the "Current Reading Resolution" dropdown, the "Current Reading (lbs)" field, and the "Reset To Factory Defaults" button.

Reset To Factory Defaults – Pressing this icon resets the field calibration back to the factory default.

## Field Calibration Procedure

1. Open Field Calibration Tab.

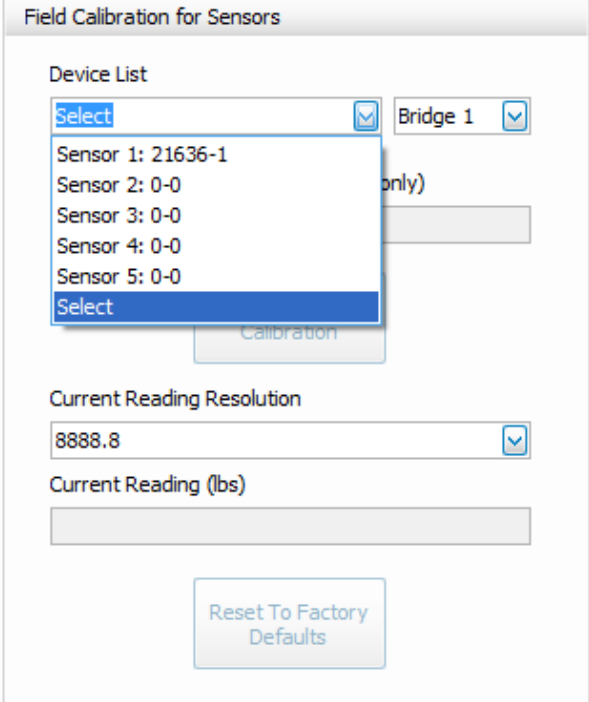

The screenshot shows the 'Field Calibration for Sensors' window. The 'Device List' dropdown menu is open, displaying a list of sensors: 'Sensor 1: 21636-1', 'Sensor 2: 0-0', 'Sensor 3: 0-0', 'Sensor 4: 0-0', and 'Sensor 5: 0-0'. The 'Select' option is highlighted at the bottom of the list. The 'Bridge 1' dropdown menu is also visible and set to 'Bridge 1'. Below the device list, the 'Current Reading Resolution' is set to '8888.8'. The 'Current Reading (lbs)' field is empty. A 'Reset To Factory Defaults' button is located at the bottom of the window.

2. Select sensor serial number and bridge from the Device List on the Field Calibration tab.

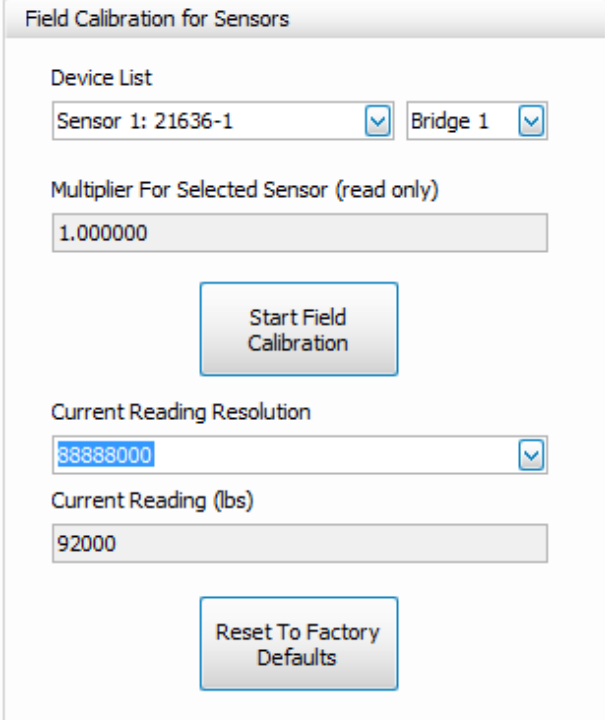

The screenshot shows the 'Field Calibration for Sensors' window with the 'Sensor 1: 21636-1' selected in the 'Device List' dropdown menu and 'Bridge 1' selected in the 'Bridge 1' dropdown menu. The 'Multiplier For Selected Sensor (read only)' field is set to '1.000000'. A 'Start Field Calibration' button is visible. Below this, the 'Current Reading Resolution' is set to '88888000' and the 'Current Reading (lbs)' field is set to '92000'. A 'Reset To Factory Defaults' button is located at the bottom of the window.

3. Click on Start Field Calibration icon.  
Note: User can abort calibration at any time by pressing Cancel.
4. At prompt, remove all load from the sensor including any tare weight.

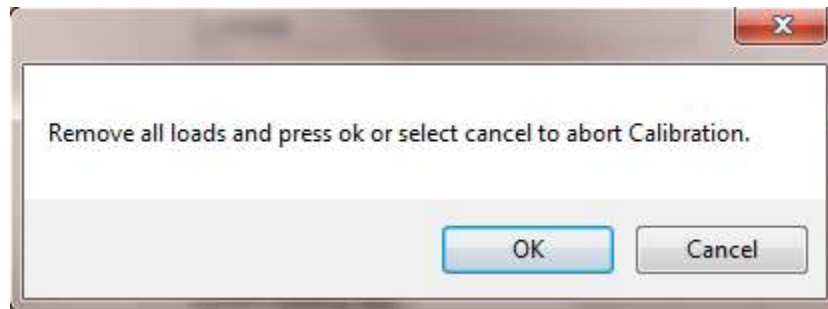

5. At prompt, press OK to record the zero output at no load.

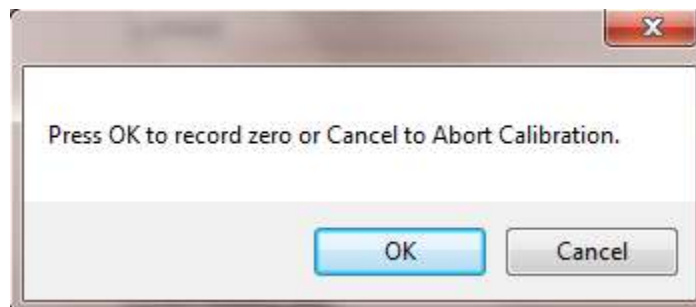

6. Add any required tare load at this time.
7. Enter Applied Load into numeric field and press OK.  
**NOTE: Applied Load must be between 40 – 100% of the sensor capacity.**

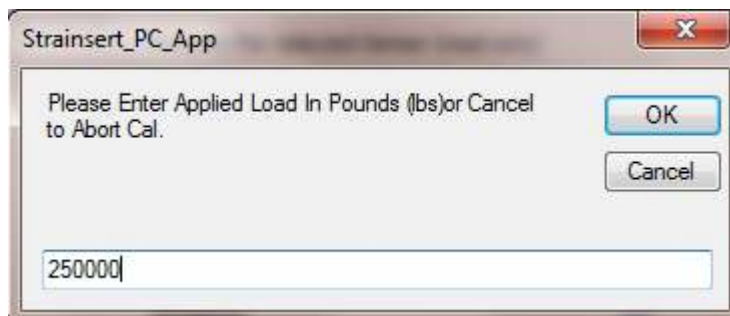

8. After prompt, pick up calibration load, wait for load to stabilize and press OK.

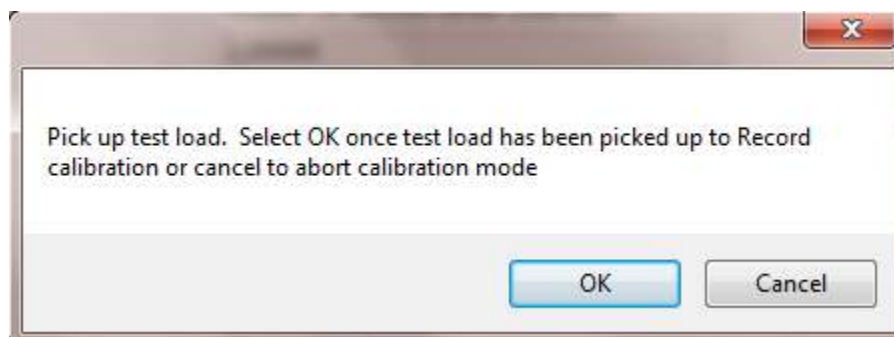



9. Wait for prompt and press OK for acceptance or Cancel to abort.

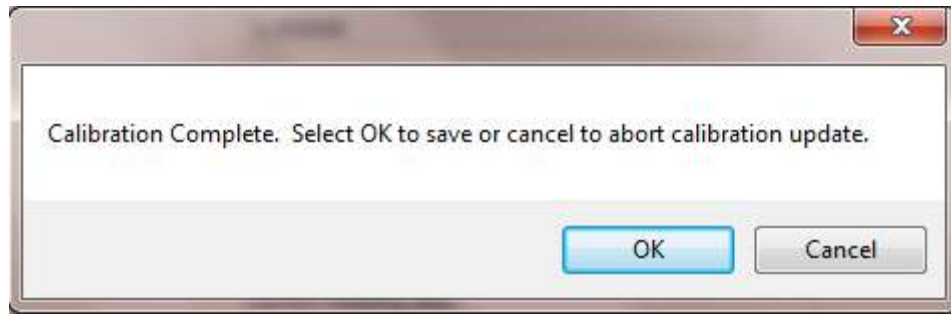

10. Field Calibration is complete.

## Data Logging

Select Sensors To Log – Select sensor to data log by checking the appropriate box.

Logging Duration – Select Hours, Minutes and Seconds for required data logging period.

Recording Frequency – Select Hours, Minutes and Seconds for required recording interval.

Data Log File Path – Defaults to C:\Strainsert\_Log\LogFile\_Startdate.txt

Note: User has option to rename file or change file path by clicking on ... icon.

Start Logging – Press icon to commence immediate data storage.

Reset Log File Path – Press icon to restore file path to factory default.

Data Logging File Format – Comma delimited text file

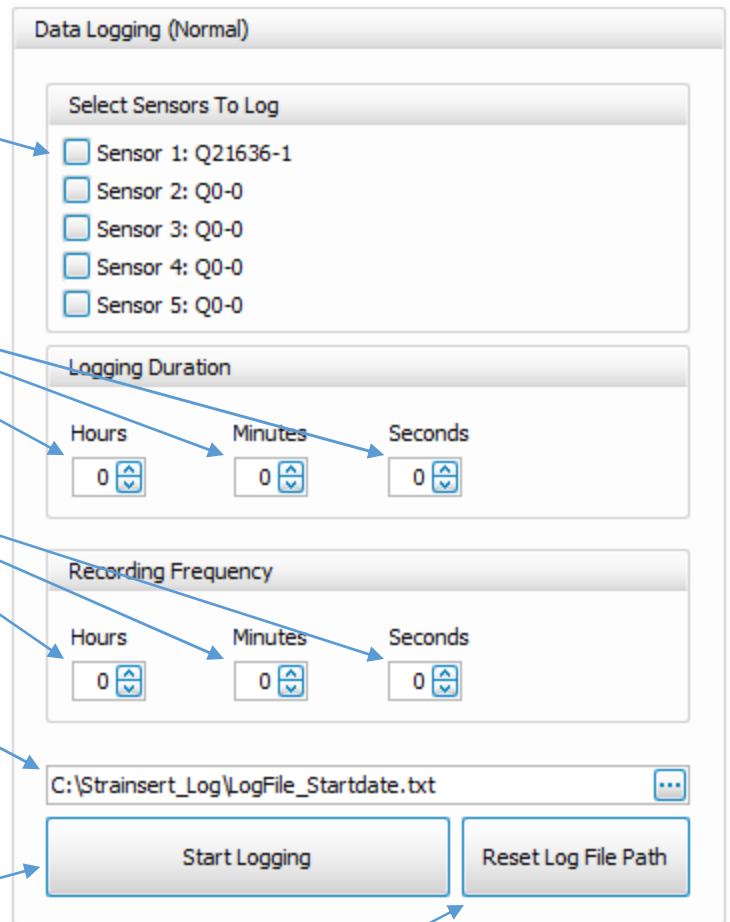
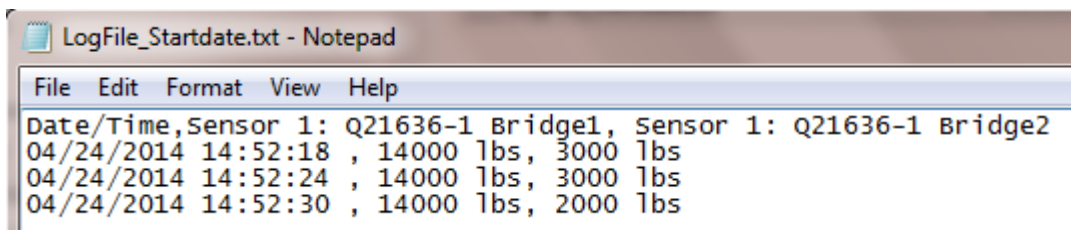
```

Date/Time, Sensor 1: Q21636-1 Bridge1, Sensor 1: Q21636-1 Bridge2
04/24/2014 14:52:18 , 14000 lbs, 3000 lbs
04/24/2014 14:52:24 , 14000 lbs, 3000 lbs
04/24/2014 14:52:30 , 14000 lbs, 2000 lbs
    
```

## Battery Installation / Replacement

1. Remove J-Unit1 cover by loosening 4 corner captive screws.



2. Take care to not lose or damage the cover gasket.
3. Pull battery from battery clips.



4. Note: The battery cable from the end of J-Unit1 circuit board will only extend approximately 3".
5. Care should be taken during the battery removal to avoid damage to the battery cable and / or circuit board receptacle.
6. Disconnect battery connector from J-Unit1 circuit board receptacle.
7. Firmly attach new battery connector to ensure connector locks into place on the J-Unit1 circuit board receptacle.
8. Re-install the battery securely into the battery clips.
9. Replace cover ensuring that the cover gasket is properly seated.

Troubleshooting

Problem	Possible Cause	Possible Solution
 No Communication	Wrong or invalid serial number	Verify serial number on sensor matches entry on Configuration tab
	Damaged or missing antenna	Verify antenna connection at the Receiver/Transmitter and the gateway
	Improper signal range selection	Change the range selection on the Configuration tab. <30-ft "Short Range" and >30-ft "Standard Range"
	Obstructed RF signal path	Reposition antenna on either the Receiver/Transmitter and / or gateway.
	Damaged gateway	Call Factory
	Damaged sensor cable	Check end to end continuity with an Ohm meter
	Damaged sensor strain gage bridge	Disconnect sensor cable at sensor and measure bridge resistance into the sensor. Consult factory for nominal bridge resistances.
	Depleted or damaged battery cell	Remove & replace battery cell at the Receiver/Transmitter
	Loose battery connection	Check battery connection at the Receiver/Transmitter
	J2 / J4 sensor inputs loose or damaged	Check J2 / J4 sensor wire harnesses at the Receiver/Transmitter board.
	Gateway / sensor communication lock	Cycle sensor battery connection, Cycle gateway USB and restart application
 OVER-RANGE	Sensor applied load exceeds approximately 40% of rated capacity	Remove applied load; call factory
	Sensor bridge circuit possibly damaged	Call Factory
 UNDER-RANGE	For a sensor configured for bi-polar operation, applied load exceeds approximately 40% of rated capacity.	Remove applied load; call factory
	For a sensor configured for uni-polar operation, applied load in reverse direction exceeds approximately 10% of rated capacity	Check sensor orientation or applied load direction.
	Sensor bridge circuit possibly damaged	Call Factory

Problem	Possible Cause	Possible Solution
No changes to displayed readings in response to change in applied load	Sensor bridge circuit possibly damaged	Call Factory
Erratic displayed readings in response to stable applied load	Sensor bridge circuit possibly damaged	Call Factory

### Customer Support

Since 1960 Strainsert has pioneered the force transducer industry. Today, we continue to champion the industry with our knowledgeable and dedicated technical, sales and manufacturing team. For application assistance, product information, and troubleshooting contact Strainsert.

### **General Contact Information**

Phone: 610-825-3310

Fax: 610-825-1734

Mailing Address:

12 Union Hill Road

West Conshohocken, PA 19428

Website: [www.strainsert.com](http://www.strainsert.com)

E-Mail: [info@strainsert.com](mailto:info@strainsert.com)